

**ENMET**

680 Fairfield Court  
Ann Arbor, MI 48108  
734.761.1270 Fax 734.761.3220

[www.enmet.com](http://www.enmet.com)

**ENMET**

Creative Gas Detection Solutions



**SE-5175**  
Sensor/Transmitter  
Operation Manual

## Table of Contents

<b>1.0 INTRODUCTION</b> .....	<b>2</b>
1.1 Unpack .....	2
1.2 Check Order .....	2
1.3 Serial Numbers.....	2
<b>2.0 COMPONENTS OF THE SE-5175</b> .....	<b>3</b>
2.1 SE-5175 elements .....	3
2.2 SE-5175 Operational Features .....	3
<b>3.0 INSTALLATION</b> .....	<b>5</b>
3.1 Mounting SE-5175.....	5
3.2 Wiring the SE-5175 .....	6
3.2.1 Power Supply.....	6
<b>4.0 OPERATION</b> .....	<b>7</b>
4.1 Start Up SE-5175 .....	7
4.1.1 Typical Start Up.....	7
4.2 Normal Display Mode.....	8
4.2.1 Alarm Conditions SE-5175 .....	8
<b>5.0 MAINTENANCE</b> .....	<b>9</b>
5.1 Maintenance Menus .....	9
5.1.1 Exit Maintenance Menu .....	11
5.2 SE-5175 Maintenance Adjustments .....	11
5.2.1 Zero Adjust.....	12
5.2.2 Gas Span.....	13
5.2.3 Alarm Set Points .....	14
5.2.4 Span Set .....	14
5.4 Sensor Replacement.....	15
<b>6.0 REPLACEMENT PARTS</b> .....	<b>16</b>
<b>7.0 TECHNICAL DATA AND SPECIFICATIONS</b> .....	<b>16</b>

## List of Tables

Table 1: Factory Alarm Set Points .....	8
Table 2: SE-5175 Maintenance Menus Sequence.....	9

## List of Illustrations

Figure 1: External SE-5175 Features .....	3
Figure 2: SE-5175 Circuit Board Features.....	4
Figure 3: Mounting SE-5175 .....	5
Figure 4: Power Terminal Connections SE-5175 .....	6
Figure 5: SE-5175 Maintenance Menu Flow Chart.....	10
Figure 6: Calibration Adapter .....	11
Figure 7: SE-5175 Sensor Replacement .....	15

### Reference Information:

**NOTE:** [important information about use of instrument]

**CAUTION:** [affects equipment – if not followed may cause damage to instrument, sensor etc...]

**WARNING:** [affects personnel safety – if not followed may cause bodily injury or death.]



Earth Ground

## 1.0 Introduction

The SE-5175 sensor/transmitter (S/T) instrument is a 3 wire, 24 VDC, 4-20mA S/T, that measures and detects various types of toxic gases utilizing an electrochemical sensor. The SE-5175 is NOT in an enclosure rated for use in a Class I, Div 1, Groups B, C, D classified area and CAN NOT be installed in a hazardous location, as defined by the National Electric Code (NEC).

Features of the SE-5175:

- continuous monitoring of the sample air
- continuous LCD display of gas and vapor concentrations
- menu driven operational and maintenance controls
- menu driven calibration procedure
- mA outputs for target gas
- Sensor/Transmitter are three wire devices, with two of the wires forming a 4-20mA loop
- Audio Alarm (optional)

**NOTE:** *All specifications stated in this manual may change without notice.*

### 1.1 Unpack

Unpack the **SE-5175** and examine it for shipping damage. If such damage is observed, notify both ENMET customer service personnel and the commercial carrier involved immediately.

#### Regarding Damaged Shipments

**NOTE:** *It is your responsibility to follow these instructions. If they are not followed, the carrier will not honor any claims for damage.*

- This shipment was carefully inspected, verified and properly packaged at **ENMET** and delivered to the carrier in good condition.
- When it was picked up by the carrier at **ENMET**, it legally became your company's property.
- If your shipment arrives damaged:
  - Keep the items, packing material, and carton "As Is." Within 5 days of receipt, notify the carrier's local office and request immediate inspection of the carton and the contents.
  - After the inspection and after you have received written acknowledgment of the damage from the carrier, contact **ENMET** Customer Service for return authorization and further instructions. Please have your Purchase Order and Sales Order numbers available.
- **ENMET** either repairs or replaces damaged equipment and invoices the carrier to the extent of the liability coverage, usually \$100.00. Repair or replacement charges above that value are your company's responsibility.
- The shipping company may offer optional insurance coverage. **ENMET** only insures shipments with the shipping company when asked to do so in writing by our customer. If you need your shipments insured, please forward a written request to **ENMET** Customer Service.

#### Regarding Shortages

If there are any shortages or questions regarding this shipment, please notify **ENMET** Customer Service within 5 days of receipt at the following address:

**ENMET**  
680 Fairfield Court  
Ann Arbor, MI 48108  
734-761-1270 Fax 734-761-3220  
Toll Free: 800-521-2978

### 1.2 Check Order

Check, the contents of the shipment against the purchase order. Verify that the **SE-5175** is received as ordered. Each **SE-5175** is labeled with its target gas. If there are accessories on the order, ascertain that they are present. Check the contents of calibration kits. Notify ENMET customer service personnel of any discrepancy immediately.

### 1.3 Serial Numbers

Each **SE-5175** is serialized. These numbers are on tags on the equipment and are on record in an ENMET database.

## 2.0 Components of the SE-5175

### 2.1 SE-5175 elements

See Figure 1 for location of elements:

Feature	Description
<b>Enclosure</b>	A fiberglass-reinforced polyester 5 x 4 x 3, with a detachable front cover. Four holes for mounting the enclosure to a vertical surface. Located at the corners of the bottom of the enclosure. See <b>Figure 3</b> .
<b>Front Cover</b>	Detachable front cover of <b>SE-5175</b> with Display Panel. See <b>Section 2.2</b> and <b>Figure 1</b> . There are 4 Screws that hold the front cover in place.

### 2.2 SE-5175 Operational Features

The Display Panel is attached to the enclosure cover and is released by unscrewing the 4 screws located in the corners. After releasing the screws and lifting the cover and exposing the interior of the enclosure, see section 3.0 for installation and wiring instructions.

See **Figure 1** for location of features.

Feature	Description
<b>Display</b>	A single line, 8-character LCD with backlight. Indicates the level of gas detected by sensor. The numerical value of gas concentration and other information is displayed.
<b>Visual Indicators and Alarms</b>	LED indicators: Power / Fault Indicator LED, Green / Red Alarm (3) Indicator LED, Red
<b>Optional Audio Alarm</b>	Horn; Activated at a preset alarm point
<b>Membrane Switches</b>	2 Pushbutton Switches on front panel control the instrument maintenance functions. The pushbutton switch locations are indicated by: <b>MENU</b> ↓: Advances the instrument display through operation information and maintenance menus <b>SELECT</b> →: Disables audio alarm temporarily and Selects the maintenance menu operations such as, Zero, Span, exit menu or sets proper calibration values for Zero or Span See <b>Section 4.0</b> and <b>5.0</b> for operational and maintenance flow charts.

Three alarm points are preprogrammed into the **SE-5175**. At each alarm point, an LED on the front panel is activated. These internal alarm settings are independent of the 4-20mA output alarm values that can be set at a controller.

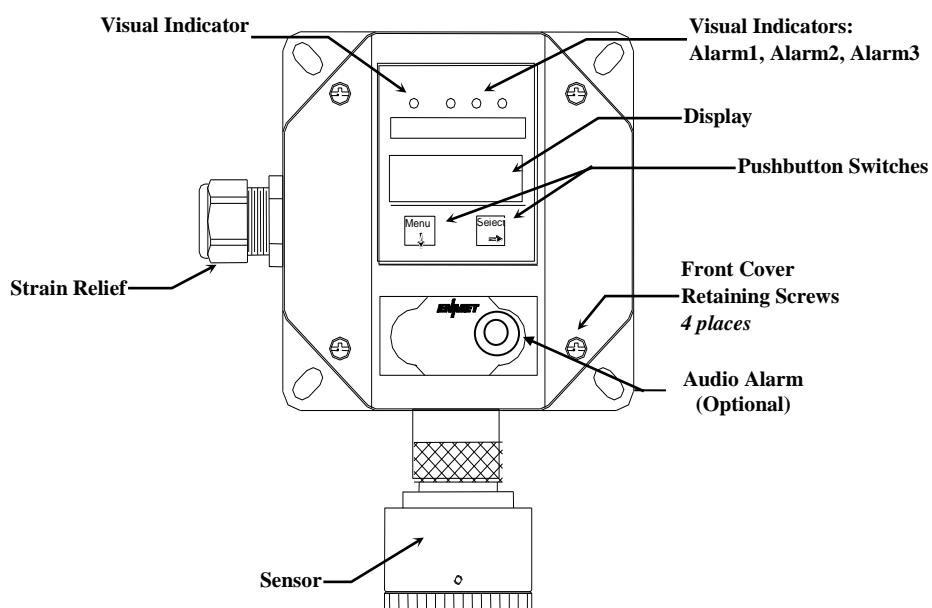

**Figure 1: External SE-5175 Features**

### 2.3 Circuit Board Features

The Display Panel is attached to the enclosure cover and is released by unscrewing the 4 screws located in the corners. After releasing the screws and lifting the cover and exposing the interior of the enclosure, see section 3.0 for installation and wiring instructions. The Circuit Board is mounted at the back surface of the enclosure Cover.

Circuit Board Features are shown in **Figure 2**.

Feature	Description
Output Terminals	J4 plug – Terminals to controller
Sensor Wiring	J8 plug – Terminals to sensor wiring

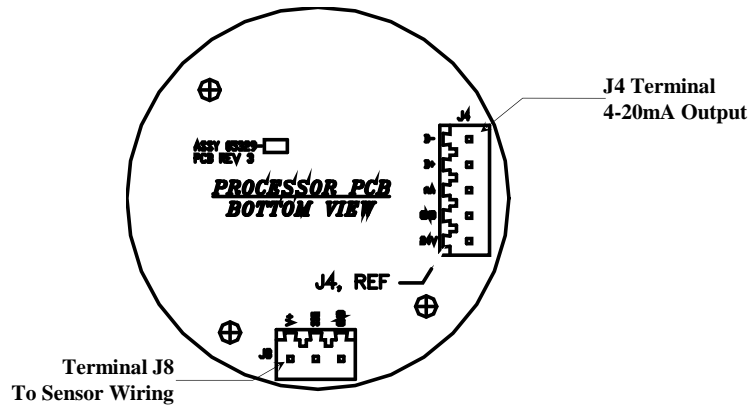

**Figure 2: SE-5175 Circuit Board Features**

### 3.0 Installation

The **SE-5175** sensor/transmitter detects gas only at the sensor location.

*NOTE: Sensor Location*

Gases have different densities. Some are heavier than air and concentrate at the bottom of a space. Some are lighter than air and gather at the top. Consider the density of the gas you want the sensor to detect when you install the sensor. Some examples are given below.

Heavier than Air Gas	Sensor Location
Hydrogen sulfide	Interior wall; 18-24" from floor. <ul style="list-style-type: none"> <li>• DO NOT locate directly above or beside gas appliances (ovens, heaters).</li> <li>• Avoid locating anywhere near a vent or window or near an outside doorway.</li> </ul>
Lighter than Air Gas	Sensor Location
Ammonia	Near ceiling. <ul style="list-style-type: none"> <li>• DO NOT locate directly above appliances where it is subject to direct exposure to heat or steam.</li> </ul>
Hydrogen	
Same Density as Air Gas	Sensor Location
Carbon Monoxide	4-6 feet above the (generally uniform) floor. <ul style="list-style-type: none"> <li>• DO NOT locate in direct air currents of windows, doors, or vents.</li> </ul>

If you have a question involving the location of a unit or sensor, please contact your distributor or **ENMET** personnel. A technician will analyze the question and recommend a location.

### 3.1 Mounting SE-5175

Mount the **SE-5175** instrument on an appropriate vertical surface, using the mounting holes provided. Avoid areas with excessive vibration or temperature extremes. The holes in the bottom of the enclosure are 0.18 inch in diameter and form a 4.09" square.

See **Figure 3**.

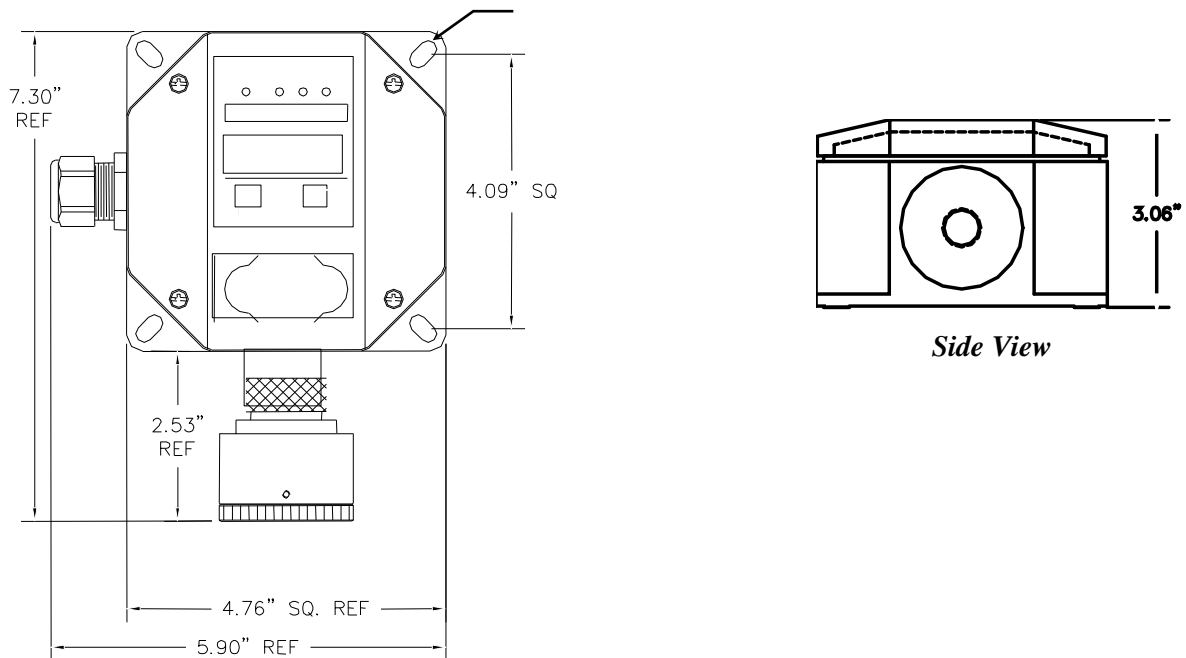

Dimensions are in inches.

**Figure 3: Mounting SE-5175**

### 3.2 Wiring the SE-5175

The electrical installation should conform to appropriate electrical codes, such as the National Electrical Code in the United States.

**WARNING:** The compliance of the installation to appropriate codes is not *ENMET*'s responsibility.

**CAUTION:** Area must be declassified during installation.

Run conduit and 16 AWG (1.5MM<sup>2</sup>) wires to the enclosure from the power supply and controller. Or use a 3 wire power cord of 0.20 to 0.35" in diameter.

After releasing the screws and lifting the cover and exposing the terminal strips on the bottom of the circuit board.

Connect the wires from the controller (power supply) to the supplied J4 plug then attach to J4 terminal.

#### 3.2.1 Power Supply

Upon supplying power to the **SE-5175**:

- The green power on LED is lit.
- The display backlight is lit, and instrument will step through a start-up sequence: unit serial number and software revision may be shown on the display.

The instrument may go into alarm briefly, but the sensors stabilize quickly. If the instrument persists in alarm, acknowledge the alarm by pressing the **SELECT** button. If alarm persists longer than 30 minutes, call *ENMET* customer service personnel.

#### J4 PLUG – TERMINAL TO CONTROLLER WIRING

Position	Function
1 +	24 VDC power
2	GND
3	4 - 20 mA out
4*	RS-485 D+
5*	RS-485 D-

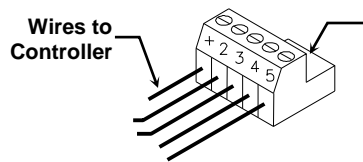

\*Contact *ENMET* for Modbus Address information

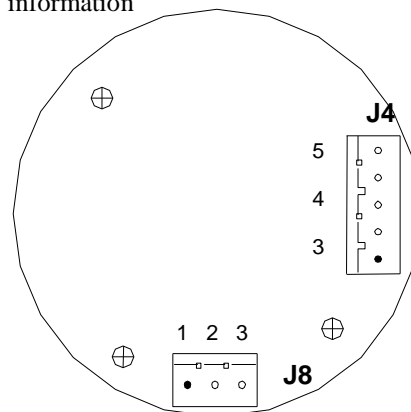

Circuit Board Bottom View

#### J8 PLUG – TERMINAL TO SENSOR WIRING

Position	Function	Sensor
1	V +	Red
2	Signal	White
3	GND	Black

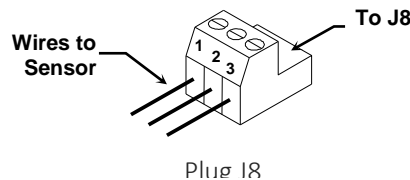

Figure 4: Power Terminal Connections SE-5175

## 4.0 Operation

### 4.1 Start Up SE-5175

When the **SE-5175** is first powered up, it goes through a series of momentary screens, which identify the instrument model number, serial number and software revision. After all of the momentary screens have been displayed, the instrument arrives at the Main Gas Display showing the gas concentration and unit of measurement, the POWER green LED is on and the red alarm and fault LEDs are not lit.

Depending on transmitter configuration and calibration condition, the furthest right character in the display may flash a letter indicating the instrument status. See the Section 4.1.1 below.

#### 4.1.1 Typical Start Up

When power is supplied to the **SE-5175**, the instrument will display the following sequence of information:

Typical start up sequence of information displayed.

##### Example of Typical Start Up Display

Display	Function
SE-5175	The instrument: Model SE-5175
84- 20	The instrument: Serial Number
S/W 6.5F	The instrument: Software Revision
IF the right most character is a flashing W 0 ppW	The instrument is in Warm-up mode <ul style="list-style-type: none"> <li>This should last about 1 minute</li> <li>The Signal Output is held at 4mA during warm-up</li> </ul>
IF the right most character is a flashing C 0 ppC	The instrument has failed Calibration The last good calibration values are retained, but the sensor may not be responsive to gas A new Calibration should be performed <i>As Soon As Possible</i>
0 ppm	The instrument: Normal Display Mode Measurement of the target gas

**NOTE:** Software revision may cause variations of display output.



## 4.2 Normal Display Mode

When the **SE-5175** is installed as described in section 3, and in clean air, the POWER green LED is on and the display is lit. The red alarm and fault LEDs are not lit.

To advance through displays of operational information press the **MENU** button.

See sequence of operational information below:

### Example of Typical Operational Display

Display Measurement of the target gas

Press **MENU** button

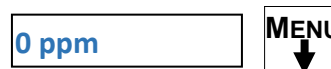

Display indicates Alarm 1 Set point

Press **MENU** button

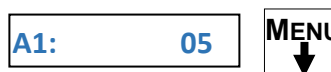

Display indicates Alarm 2 Set point

Press **MENU** button



Display indicates Alarm 3 Set point

Press **MENU** button



Display indicates mA Span range

(Full Scale)

Press **MENU** button



Display returns to operational measurement

### Operational Display Flow Chart

#### 4.2.1 Alarm Conditions SE-5175

There are three alarm set points. The factory settings of these alarm set points are shown in **Table 1**.

**Table 1: Factory Alarm Set Points**

Gas	Alarm 1	Alarm 2	Alarm 3
Ammonia	25 ppm	50 ppm	75 ppm
Arsine	0.05 ppm	0.1 ppm	0.4 ppm
Carbon Monoxide	35 ppm	50 ppm	200 ppm
Chlorine	0.5 ppm	1 ppm	5 ppm
Ethylene Oxide	3 ppm	5 ppm	9 ppm
Hydrogen	200 ppm	500 ppm	1000 ppm
Hydrogen Chloride	5 ppm	10 ppm	20 ppm
Hydrogen Fluoride	3 ppm	6 ppm	9 ppm
Hydrogen Sulfide	10 ppm	20 ppm	50 ppm
Nitric Oxide	25ppm	50 ppm	75 ppm
Nitrogen Dioxide	3 ppm	5 ppm	10 ppm
Oxygen	17% V	19.5% V	23.5V
Ozone	0.1 ppm	0.5 ppm	0.75 ppm
Saline	5 ppm	10 ppm	20 ppm
Sulfur Dioxide	2 ppm	5 ppm	10 ppm

These alarm set points can be changed within limits; see the maintenance section of this manual for the procedure.

If the target gas concentration increases above that of the alarm set point, the associated red LED is lit, the associated relay changes state, and the audio alarm is activated. Oxygen is the exception with descending and rising alarm points.

## 5.0 Maintenance

The **SE-5175** maintenance menus that are accessed by pressing the **MENU** button and entering a valid access code. The access code is set at the factory and may be changed by following the access code menu explained in section 5.5.

### 5.1 Maintenance Menus

**CAUTION:** Do Not Attempt A Span Procedure Without Calibration Gas Applied to The Sensor; if this is done, the instrument is forced into a calibration fault mode.

Pushbutton switches control the **MENU** and **SELECT** functions. The **MENU** and **SELECT** button locations are indicated on the display panel, see **Figure 3**. The **MENU** button is used to display the various menu options and make incremental changes to numbers such as alarm points, calibrations gas, etc. The **SELECT** button is used to select that option, set zero or span digit. To enter the maintenance menu press and hold the **MENU** button for 2 to 4 seconds

**Table 2** indicates the maintenance menu sequence see **Figure 5** for a detailed maintenance menu flow chart.

**Table 2: SE-5175 Maintenance Menus Sequence**

Example of Display	Function
<div style="border: 1px solid black; padding: 5px; display: inline-block; margin: 10px auto; width: 100px; text-align: center;">5ppm</div> Normal Display Mode	Measurement of CO
Press and <i>hold</i> the <b>MENU</b> button for 2 – 4 seconds to enter the Maintenance Menu The Power/Fault LED will flash Green – Red to indicate the <b>SE-5175</b> is in Maintenance Mode	
<div style="border: 1px solid black; padding: 5px; display: inline-block; margin: 10px auto; width: 100px; text-align: center;">Exit</div>	To exit the maintenance Menu and return to the Normal Display Mode: If intended function Press <b>SELECT</b> button
Press the <b>MENU</b> button to advance to the Zero procedure	
<div style="border: 1px solid black; padding: 5px; display: inline-block; margin: 10px auto; width: 100px; text-align: center;">Zero</div> <i>Not Available for Oxygen units</i>	For adjusting Zero: If intended function Press <b>SELECT</b> button
Press the <b>MENU</b> button to advance to the Span procedure	
<div style="border: 1px solid black; padding: 5px; display: inline-block; margin: 10px auto; width: 100px; text-align: center;">Span</div>	For adjusting the Span: If intended function Press <b>SELECT</b> button
Press the <b>MENU</b> button to advance to each Alarm set point procedures	
<div style="display: flex; justify-content: space-around; align-items: center;"> <div style="border: 1px solid black; padding: 5px; margin: 10px auto; width: 100px; text-align: center;">Alarm1</div> <div style="border: 1px solid black; padding: 5px; margin: 10px auto; width: 100px; text-align: center;">Alarm2</div> <div style="border: 1px solid black; padding: 5px; margin: 10px auto; width: 100px; text-align: center;">Alarm3</div> </div>	For adjusting the Alarm 1, 2 and 3 set points: If Intended function, Press <b>SELECT</b> button.
Press the <b>MENU</b> button to advance the mA Span set point procedure	
<div style="border: 1px solid black; padding: 5px; display: inline-block; margin: 10px auto; width: 100px; text-align: center;">mA Span</div>	For adjusting the mA Span set point: If intended function Press <b>SELECT</b> button

Pressing the **MENU** button without pressing the **SELECT** button will allow you to cycle through the menu options. You must Press the **SELECT** button in order to initiate the desired operation.

Normal Gas Display

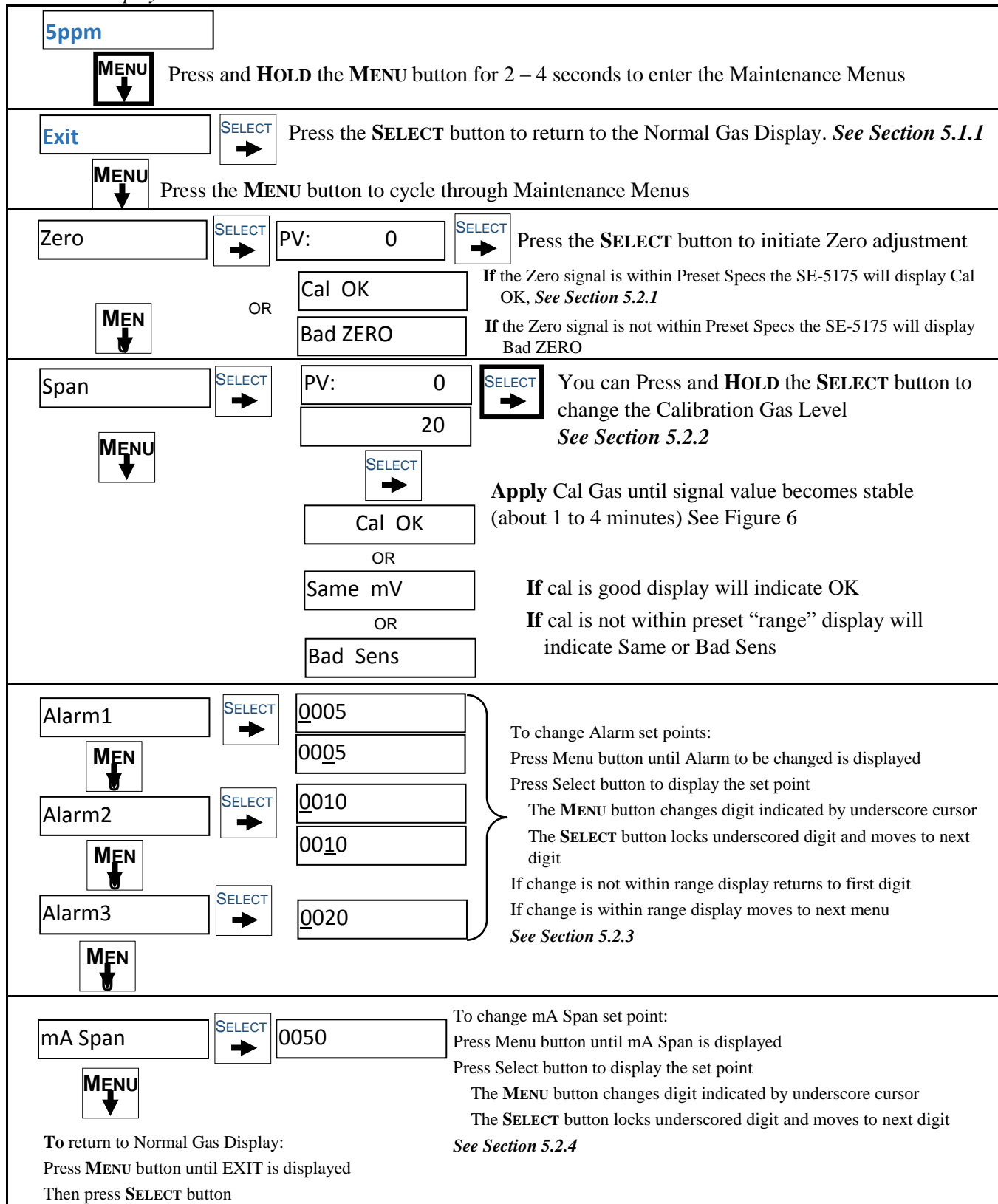
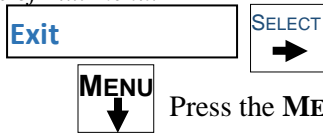

**FIGURE 5: SE-5175 Maintenance Menu Flow Chart**

### 5.1.1 Exit Maintenance Menu

Exit maintenance, when the Exit appears on the display. Press the **SELECT** button to return to the instrument Normal Gas Display.

Example of Exit menu:



Press the **SELECT** button to return to the Normal Gas Display.

Press the **MENU** button to cycle through Maintenance Menus

## 5.2 SE-5175 Maintenance Adjustments

### Calibration of the SE-5175

Calibration is the process of setting the instrument up to read accurately when exposed to the target gas. The Zero function sets the clean air reference point and the Span function sets the sensitivity of the instrument.

**Initial Calibration:** Wait 3 – 4 hours after initially supplying power to the **SE-5175** instrument before initial calibration. The **SE-5175** has been precalibrated at the factory, and initial field calibration should result in only fine tuning to circuit, as well as a way to check that installation is successful. It is not necessary to open the enclosure to make adjustment. The calibration functions are operated with pushbuttons from outside the enclosure through the **MENU** and **SELECT** switches.

Calibration Zero and Span functions are two separate procedures. They operate independently of each other. It is recommended that the Zero procedure be done prior to the Span procedure.

NOTE: Zero function is not used for Oxygen transmitters.

*ENMET recommends at least quarterly calibration of the SE-5175 instrument.*

Calibration equipment is available from **ENMET** to calibrate the **SE-5175** instrument.

- Calibration adapter, a length of tubing with a regulator for the gas cylinder on one end, and a fitting to connect to the **SE-5175** sensor/transmitter on the other.
- Gas cylinder, Zero gas 20.9% oxygen or Span gas, typical 50% of instrument full scale.

Generally, a cylinder of 20.9% Oxygen is used to provide a Zero point or fresh air reference for the calibration.

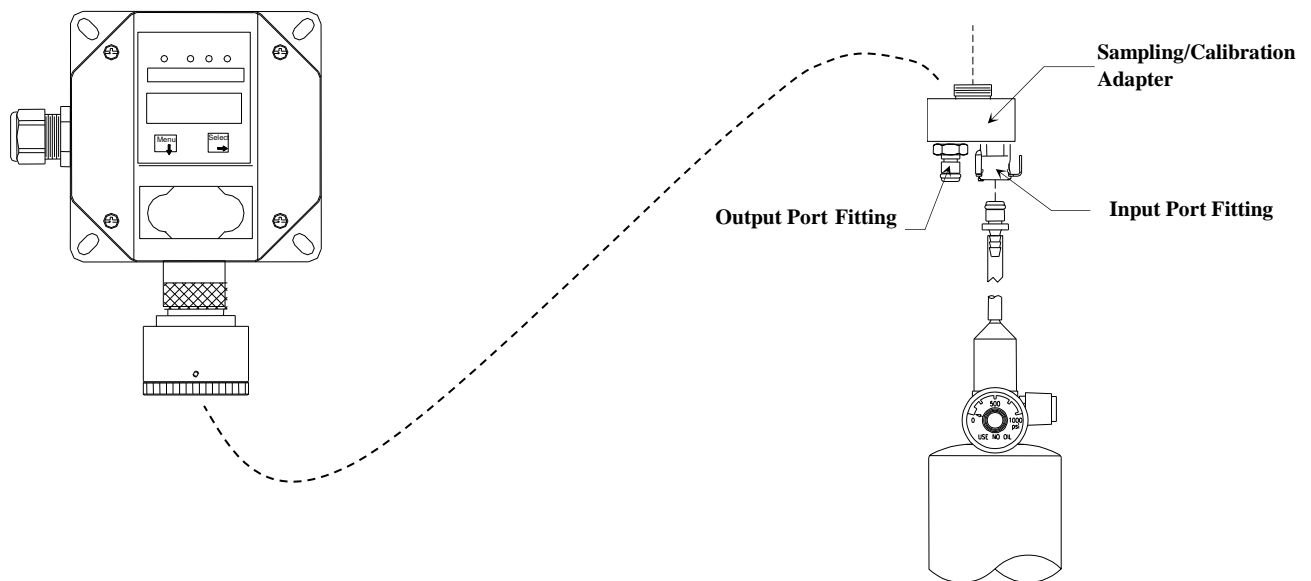

**Figure 6: Calibration Adapter**

**5.2.1 Zero Adjust**

**NOTE:** Zero function is not used for Oxygen transmitters, proceed to Gas Span.

The ZERO function must be performed by exposing the **SE-5175** instrument to clean fresh air. If the air at the sensor is in question, use a cylinder of 20.9% oxygen to provide a clean air reference. See **Figure 6**  
 Enter the maintenance menu by pressing and holding **MENU** button for 2 to 4 seconds. See **Figure 5, SE-5175 Maintenance Menu** flow chart.

After entering the maintenance menu, Press the **MENU** button until the Zero menu is displayed.  
 Press the **SELECT** button to perform a Zero.

The display will alternate between Zero and PV: To abort Zero function press and hold **MENU** button for 3 – 4 seconds, Abort? will appear, press **SELECT** button to return to Zero.

Press the **SELECT** button to initiate a Zero adjustment.

An auto detect sequence is initiated. After 15 seconds, the **SE-5175** will monitor the zero reading for stability.

- *If the reading stabilizes*, within the pre-programmed perimeters, an automatic zero adjustment will be made. Cal OK appears on the display and in 1 – 2 seconds, display will change to Span.  
 If you wish to Span the sensor press the **SELECT** button you are now ready to apply gas. **Proceed to gas span step 2**  
 If you wish to Exit the maintenance menu, press **MENU** button until Exit is displayed, then press **SELECT** button to return to the instrument Normal Gas Display
- *If the reading does not stabilize*, within 255 seconds, the procedure will be aborted. Sensor is outside of safe parameters to be zeroed, the display will read Bad Zero. Repeat Section 5.2.2 Zero Adjust making sure to use a Zero gas of 20.9% Oxygen. **ENMET** part number 03296-209.

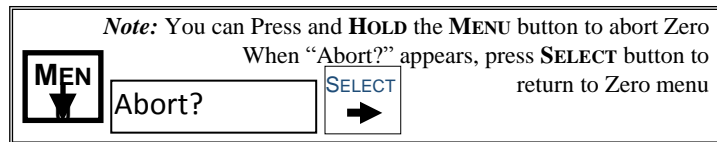

*Example of Zero adjustment display:*

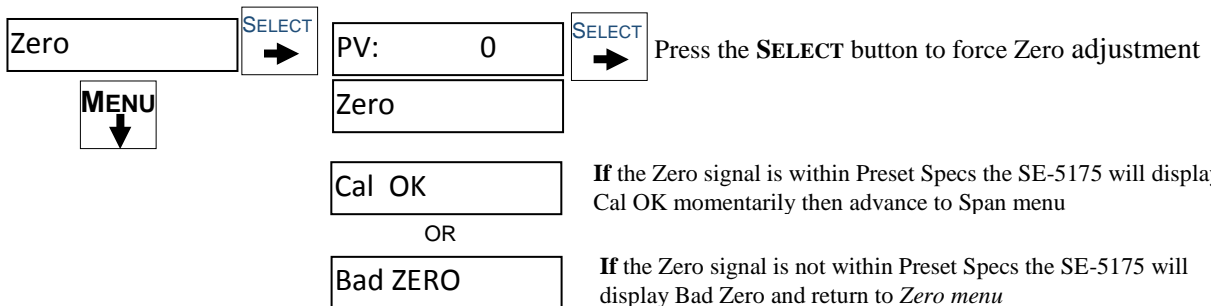

### 5.2.2 Gas Span

It is recommended that the Zero Function be performed first.

Do not perform a calibration unless span gas is applied to sensor. Calibration can be aborted by pressing and holding the **MENU** button for 3 – 4 seconds.

Enter the maintenance menu. See **Figure 5, SE-5175** Maintenance Menu flow chart.

1. Press the **MENU** button until Span display.
2. Press the **SELECT** button to perform a Span procedure.  
 The display will alternate between the calibration gas concentration: example (Cal 20) and a signal level (PV).  
 To Abort calibration press and Hold **MENU** button for 3 – 4 seconds, Abort? will appear, press **SELECT** button to return to Span.  
 To change calibration gas level to be used, press and Hold **SELECT** button for 3 – 4 seconds, use menu button to change digit and select button to move to next digit.
3. Attach the associated calibration gas cylinder to the calibration adapter. See **Figure 6** on calibration adapter.
4. Open the valve to apply the calibration gas to the sensor.  
 An auto detect sequence is initiated after 30 seconds, the **SE-5175** will monitor the cal reading for stability.
5. Watch for the signal level to stabilize. 1 – 4 minutes.
6. Once the signal level has stabilized,
  - If the Span is successful, “Cal OK” appears momentarily, then will advance to Alarm1 menu.
  - If the sensor is outside of acceptable parameters, “Bad Span” is displayed.
  - If the sensor did not respond, an incompatible span gas was applied and the sensor did not respond at all, “Same mV” is displayed then will return to Span.  
 → If calibration is not successful, it is suggested that calibration be attempted again in 30-60 minutes.  
 If the sensor will not calibrate See Section 5.4.
7. Remove the calibration gas.
8. Calibration is complete.  
 Note: The instrument will return to operation mode in 3 – 5 seconds.
9. Press the **MENU** button to advance to next desired menu

Example of Calibration Display:

**NOTE:** To abort calibration or change calibration gas level.

You can Press and **HOLD** the **MENU** button to abort Calibration

When “Abort?” appears, press **SELECT** button to advance to Alarm1 menu

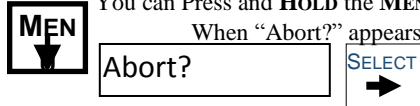

You can Press and **HOLD** the **SELECT** button to change the Calibration Gas Level

-Use the **MENU** button to change digits  
 -Use the **SELECT** button to move to next digit

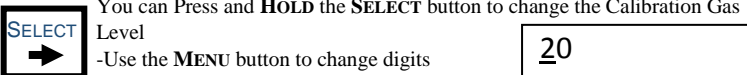

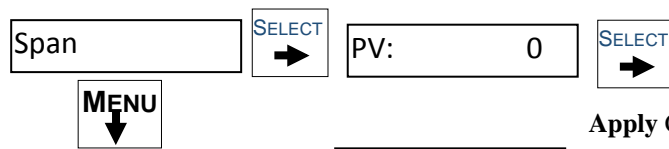

**Apply** Cal Gas until signal value becomes stable (about 1 to 4 minutes) See **Figure 6**

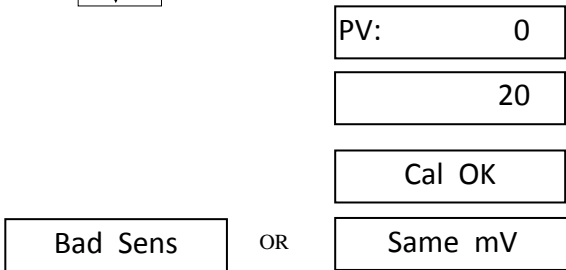

When cal signal is stable **SE-5175** will automatically update:  
**If** cal is good display will indicate OK or Same and advance to Alarm1  
**If** cal is not within preset “range” display will indicate Bad Sens or Same mV The **SE-5175** will return to the Span Menu  
 To exit press **MENU** button until Exit appears and press **SELECT**

### 5.2.3 Alarm Set Points

The SE-5175 alarm set points can be changed within limits. See **Table 1** for factory set alarm points.

To change any of the three alarm points:

Enter the maintenance menu as shown in **Figure 5 SE-5175 Maintenance Menu** flow chart.

1. Press the **MENU** button until Alarm1 is displayed.
2. Press the **SELECT** button to initiate alarm set point change
3. Press the **MENU** button to change the digit indicated by the underscore cursor
4. Press the **SELECT** button to move the cursor to the next digit  
When last digit is entered the SE-5175 will advance to the next menu
5. Press the **MENU** button to advance to the next menu

Example of Alarm Set Point menus:

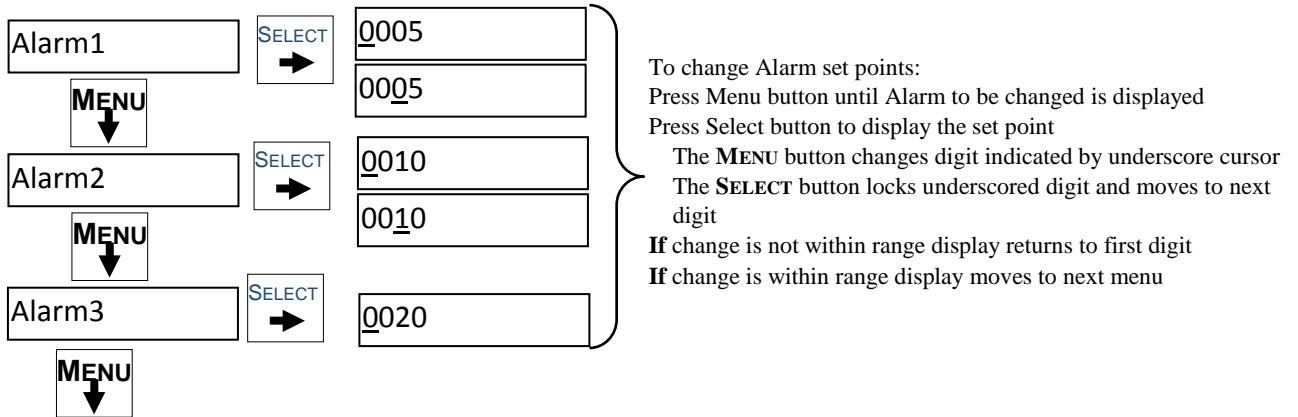

### 5.2.4 Span Set

The SE-5175 4-20mA span range can be changed within limits.

To change the span range:

Enter the maintenance menu as shown in **Figure 5 SE-5175 Maintenance Menu** flow chart.

1. Press the **MENU** button until Span is displayed.
2. Press the **SELECT** button to initiate the mA Span menu
3. Press the **MENU** button to change the digit indicated by the underscore cursor
4. Press the **SELECT** button to move the cursor to the next digit  
When last digit is entered the SE-5175 will advance to the next menu
5. Press the **MENU** button to advance to the next menu

Example of mA Span menu:

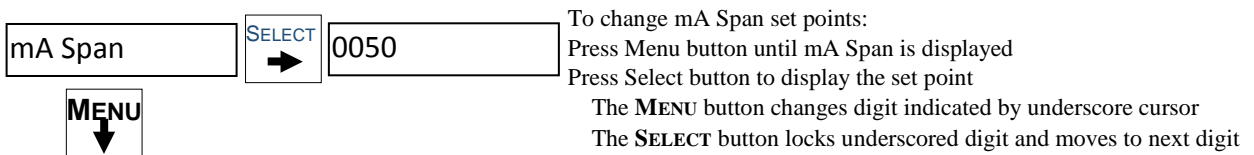

Default mA Span

4mA	20mA (full Scale Point)
0 ppm	50 ppm (Example)

## 5.4 Sensor Replacement

**WARNING:** Power must be removed from the SE-5175 before this or any internal procedure. Failure to do so may cause damage to equipment, bodily injury or death.

Sensors should be replaced when they can no longer be calibrated. Replacement sensor part numbers are listed in **Section 6.0** of this manual. If you do not know the proper part number for your sensor, have the **SE-5175** serial number available when contacting your Distributor or **ENMET** Technical Support.

1. Remove the set screw from **SE-5175** sensor head, and remove the sensor cap. See **Figure 7**.

**NOTE:** Set screw *must* be loosened before attempting to rotate or remove the sensor housing cap.

2. Remove the sensor assembly. See **Figure 7**.
3. Insert the new sensor assembly.
4. Replace the sensor cap and replace the set screw.
5. Resupply power to the **SE-5175**.

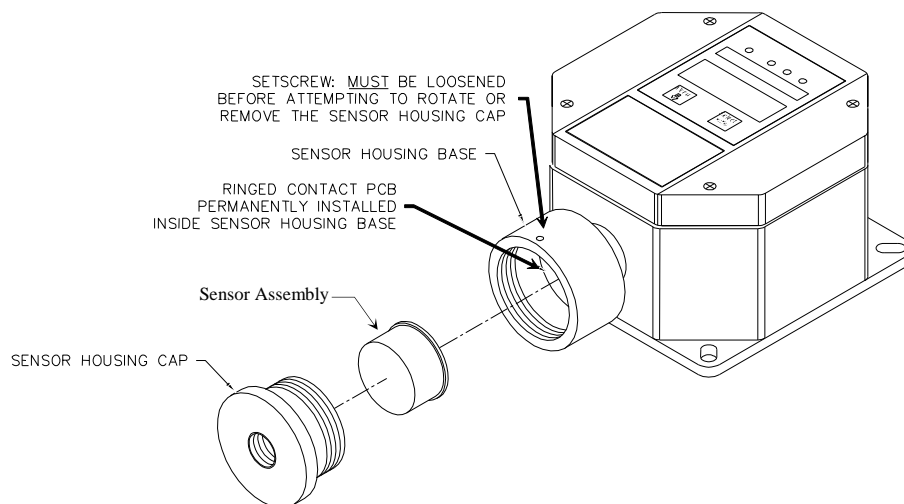

**Figure 7: SE-5175 Sensor Replacement**

After the new sensor assembly has been installed, it is suggested to allow the sensor to stabilize for 3 – 4 hours.

### A Factory calibration must be performed.

When entering the Maintenance menu EXIT will be displayed. Press and *hold* the **MENU** button for 2-4 seconds. Press the **MENU** switch to change display to Zero or Span.

An F will appear on the far right hand side of the display. The F indicates that the instrument is in Factory mode.

Perform the calibration Zero and Span procedures as outlined in **Section 5.2**. Be sure that the F is present when selecting the Zero and Span functions.

The Factory calibration sets a calibration window for future standard instrument calibrations.



## 6.0 Replacement Parts

ENMET replacement part numbers:

Description of Part	Part Number
Sensor – Contact <i>ENMET</i>	67027-xxxx
Calibration Adapter	03700-034
Calibration Regulator, 58/103 liter	02506-002
Calibration Regulator, 34 liter	02506-004
Zero Gas, 20.9% O <sub>2</sub> , 34 liter	03296-209
Calibration gas – Contact <i>ENMET</i>	

## 7.0 Technical Data and Specifications

<b>Electrical Power</b>	24 VDC	
	0.6A, 24VDC	
<b>Storage and Transport</b>	Temperature:	-20° to +60°C (-4° to +140°F)
	<i>preferred</i>	0° to +20°C (32° to 68°F)
	Relative Humidity	10-99% RH, non-condensing
	Atmospheric Pressure	20 to 36 inHg (68 to 133 kPa)
<b>Operation</b>	Temperature:	0° to +40°C (32° to +104°F)
	Relative Humidity	10-99% RH, non-condensing
	Atmospheric Pressure	20 to 36 inHg (68 to 133 kPa)
<b>Mechanical</b>	Dimensions:	
	Weight:	
	Material:	
<b>Outputs</b>	Strain relief:	3-6.5mm OD, 1 supplied

**NOTE:** All specifications stated in this manual may change without notice.

## 8.0 Terms and Conditions

### 8.1 Ordering Information

Address orders to:

**ENMET**  
Attention: Customer Service Department  
680 Fairfield Court  
Ann Arbor, MI 48108

Email Orders: [orderentry@enmet.com](mailto:orderentry@enmet.com)

Phone: 734-761-1270

Fax: 734-761-3220

You may also contact our customer service department by email [info@enmet.com](mailto:info@enmet.com). MINIMUM ORDER IS \$50.00.

### 8.2 Shipping Terms

All shipments are F.O.B. ENMET's facility in Ann Arbor, MI, USA or Bowling Green, KY, USA. Shipping and handling charges are prepaid and added, and must be paid by the customer. Shipping and handling charges may be billed to VISA, MasterCard, American Express, or to the customer's preferred carrier account number. Delivery to the carrier constitutes delivery to the customer, and risk of loss passes to the customer at that time, however, title shall remain with ENMET until payment is received in full. Claims for shortages and damage must be made by the customer to the carrier within 5 days of receipt. **Refer to section "1.1 Unpack" for more information on this matter.**

A special service of \$50.00, or more, may be assessed on expedited shipments.

**NOTE:** Calibration gases are classified as Dangerous Goods for transportation purposes, and shipping companies charge a hazardous material fee for processing the documentation required for handling such items. Also, other restrictions apply to shipment of Danger Goods by air. Check with **ENMET** for clarification and additional information.

### 8.3 Payment

Open accounts must be established in advance with ENMET's accounting department.

Address Payments to:

**ENMET**  
680 Fairfield Court  
Ann Arbor, MI 48108

Phone: 734-761-1270

We accept payments by VISA, MasterCard, and American Express. Payment by credit card must be specified at time of order placement. Your credit card will be charged on the date of shipment.

**ENMET** invoices for products that are shipped on open account are due and payable 30 days from the date of shipment from the **ENMET** site. **ENMET** may institute collection services should any bona fide invoice remain unpaid with no payment schedule negotiated by the customer with the **ENMET** Accounting Department. Any cost incurred by **ENMET** for professional collection services or legal fees to collect on a customer invoice will be added to any future business conducted between **ENMET** and that customer.

### 8.4 Warranty Information and Guidelines

Equipment must be returned prepaid to the point of origin, and ENMET will prepay the return transportation charges.

Transportation prepaid by ENMET will be by most economical means (e.g. FedEx Ground). If an expedient means of transportation is requested during the warranty period, the customer must pay the difference between the most economical means and the expedient mode. ENMET warrants new instruments to be free from defects in workmanship and material under normal use for a calibration and expendable parts such as filters, detector tubes, batteries, etc. In addition, some oxygen cells and other sensors are limited to a warranty period of six months from date of shipment. Refer to the instrument manual for specific warranty details. If the inspection by ENMET confirms that the product is defective, it will be repaired or replaced at no charge, within the stated limitations, and returned prepaid by FedEx Ground to any location in the United States. ENMET shall not be liable for any loss or damage caused by the improper use or installation of the product. The purchaser indemnifies and holds harmless the company with respect to any loss or damages that may arise through the use by the purchaser or others of this equipment. This warranty is expressly given in lieu of all other warranties, either expressed or implied, including that of merchantability, and all other obligations, or liabilities of ENMET which may arise in connection with this equipment. ENMET neither assumes nor authorizes any representatives or other persons to assume for it any obligation or liability other than that which is set forth herein. If a component is purchased and installed in the field, and fails within the warranty term, it can be returned to ENMET and will be replaced, free of charge. If the entire instrument is returned to ENMET with the defective item installed, it will be replaced at no cost, but the instrument will be subject to labor charges at half of the standard rate.

**NOTE:** When returning an instrument to the ENMET for service:

- o Be sure to include all paperwork (the “Request for Service” form).
- o Include any specific instructions.
- o For warranty service, include the date of purchase.
- o If you require an Estimate, please contact ENMET.

The “Request for Service” form is on the final page of this manual. This form can be copied or used as needed. For service requests, outside of the warranty period, please refer to the “Returning an Instrument for Service Instruction” found later in this section.

### 8.5 Return Policy

**All returns for credit must be approved by ENMET and identified with a “Return Material Goods” number.** Such returns are subject to a minimum of a \$50.00 or 20% restocking fee, whichever is greater. **Approval of equipment for return is fully at the discretion of ENMET.** All requests for return/exchange must be made no later than 30 days of the original shipping date from *ENMET*. The actual amount of any resulting credit will not be determined prior to a complete inspection of the equipment by *ENMET*. Calibration gas cylinders cannot be returned or restocked due to the Department of Transportation refill restrictions. Air Filtration Systems (AFS series & parts) cannot be returned or restocked because their internal surfaces and filters are not amenable to re-inspection.

**Certain products, such as stationary systems, or instruments with custom sensor configuration (non-standard) are built to order, and cannot be returned.** Cancellation of orders for custom-built products, prior to shipment, will result in the assessment of a cancellation fee. The amount of the cancellation fee will be based upon the size and complexity of the order, and the percentage of total cost expended prior to cancellation.

### 8.6 Returning an Instrument for Service Instructions

Contact the ENMET Service Department for all service requests.

Phone: 734-761-1270

Email: repair@enmet.com

Fill out the “Service Request Form” found at the end of this manual and return with your instrument for all needs. Please send your instrument for service to the site in which the product was purchased. A new “Service Request Form” may be requested if the one found in the manual is not available. All instruments should be shipped prepaid to ENMET.

Address for Service:

Michigan Location:

**ENMET**  
Attention: Service Department  
680 Fairfield Court  
Ann Arbor, MI 48108

Kentucky Location:

**ENMET**  
62 Corporate Court  
Bowling Green, KY 42103

Providing the “Service Request Form” assists in the expedient service and return of your unit and failure to provide this information can result in processing delays. *ENMET* charges a one hour minimum billing for all approved repairs with additional time billed to the closest tenth of an hour. All instruments sent to *ENMET* are subject to a minimum evaluation fee, even if returned unrepared. Unclaimed instruments that *ENMET* has received without appropriate paperwork or attempts to advise repair costs that have been unanswered after a period of 60 days may, be disposed of or returned unrepared COD and the customer will be expected to pay the evaluation fee. Serviced instruments are returned by UPS/FedEx Ground and are not insured unless otherwise specified. If expedited shipping methods or insurance is required, it must be stated in your paperwork.

**NOTE:** Warranty of customer installed components.

For Warranty Repairs, please reference *ENMET*'s “Warranty Information and Guidelines” (found earlier in this section).

**Mailing/Shipping Address:**

ENMET  
680 Fairfield Court  
Ann Arbor, MI 48108  
[repair@enmet.com](mailto:repair@enmet.com)



**Phone: 734.761.1270**  
**Fax: 734.761.3220**

**Service Request Form**

**Product Name or Number:**

**Product Serial Number:**

**Describe Problem or Needed Service:**

**Warranty Claim?**  Yes  No

**CUSTOMER INFORMATION**

**Billing Address:**

**Shipping Address:**

\_\_\_\_\_  
\_\_\_\_\_  
\_\_\_\_\_

**Contact Name:** \_\_\_\_\_

**Phone #:** \_\_\_\_\_

**Email:** \_\_\_\_\_

**Fax #:** \_\_\_\_\_

**PO/Reference**

**#:** \_\_\_\_\_

**PAYMENT METHOD**

COD  VISA/MasterCard  American Express

Card Number

Exp. Date

Security Code:

**Name as it Appears on**

**Card:** \_\_\_\_\_

**RETURN SHIPPING METHOD**

UPS Ground  UPS 3 Day Select  UPS Next Day Air  UPS ND Air Saver  UPS 2 Day Air

UPS Account #: \_\_\_\_\_

FedEx Ground  FedEx Air Express Saver  FedEx Air Overnight Std.  FedEx Air 2 Day  FedEx Air Overnight P-1

FedEx Account #: \_\_\_\_\_

Insure Shipment:  Yes  No

Insurance \$  
Amount: \_\_\_\_\_