



EX-5165
Sensor Transmitter
Operation and Maintenance Manual

Table of Contents

1.0 INTRODUCTION	2
1.1 Unpack	2
1.2 Check Order	2
1.3 Serial Numbers.....	2
2.0 FEATURES OF THE EX-5165	3
Select.....	3
External View	3
Menu	3
Select.....	3
Internal PCB View.....	3
NOTE: POT 2, POT 3and POT 4 are not used, Do Not Adjust	3
3.0 INSTALLATION OF THE EX-5165	4
3.1 Mounting the EX-5165 Enclosure	4
3.2 Wiring the EX-5165 to a Control Unit.....	5
4.0 OPERATION OF THE EX-5165	7
4.1 Start up.....	7
4.1.1 Typical Start Up.....	7
4.2 Normal Display Mode.....	8
4.2.1 Alarm Conditions EX-5165	8
5.0 MAINTENANCE OF THE EX-5165	9
5.1 Maintenance Menu.....	9
5.2 Calibration of the EX-5165.....	10
5.2.1 Zero Adjust.....	10
5.2.2 Gas Span.....	11
5.2.3 Exit Maintenance Menu	11
5.3 Sensor Replacement	13
6.0 REPLACEMENT PART NUMBERS	14
Part Number	14
7.0 TERMS AND CONDITIONS	15
7.1 Ordering Information	15
7.2 Shipping Terms	15
7.3 Payment	15
7.4 Warranty Information and Guidelines	15
7.5 Return Policy	16
7.6 Returning an Instrument for Service Instructions	16

List of Figures

Figure 1: EX-5165 Features.....	3
Figure 2: EX-5165 Mounting Dimensions.....	4
Figure 3: Terminal Positions EX-5165 Sensor/Transmitter.....	6
Figure 4: Calibration Adapter EX-5165 Sensor/Transmitter	10
Figure 5: EX-5165 Maintenance Menu Flow Chart.....	12
Figure 6: Sensor Replacement	13

List of Tables

Table 1: EX-5165 Maintenance Menus Sequence	9
---	---

Reference Information:

NOTE: [important information about use of instrument]

CAUTION: [affects equipment – if not followed may cause damage to instrument, sensor etc....]

WARNING: [affects personnel safety – if not followed may cause bodily injury or death.]



Attention / Warning



Earth Ground

1.0 Introduction

The **ENMET EX-5165** infrared sensor/transmitter (S/T) is a 3-wire, 24VDC 4-20mA S/T for the detection of Carbon Dioxide (CO₂). The **EX-5165** is meant to be used in conjunction with an appropriate power supply and controller. The **ENMET EX-5165** sensor/transmitter has been designed and approved to be used in a Class I, Div. 1, Groups B, C, D, classified areas. The approval was issued by CSA International.

NOTE: *All specifications stated in this manual may change without notice.*

1.1 Unpack

Unpack the **EX-5165** and examine it for shipping damage. If such damage is observed, notify both **ENMET** customer service personnel and the commercial carrier involved immediately.

Regarding Damaged Shipments

NOTE: *It is your responsibility to follow these instructions. If they are not followed, the carrier will not honor any claims for damage.*

- This shipment was carefully inspected, verified and properly packaged at **ENMET** and delivered to the carrier in good condition.
- When it was picked up by the carrier at **ENMET**, it legally became your company's property.
- If your shipment arrives damaged:
 - Keep the items, packing material, and carton "As Is." Within 5 days of receipt, notify the carrier's local office and request immediate inspection of the carton and the contents.
 - After the inspection and after you have received written acknowledgment of the damage from the carrier, contact **ENMET** Customer Service for return authorization and further instructions. Please have your Purchase Order and Sales Order numbers available.
- **ENMET** either repairs or replaces damaged equipment and invoices the carrier to the extent of the liability coverage, usually \$100.00. Repair or replacement charges above that value are your company's responsibility.
- The shipping company may offer optional insurance coverage. **ENMET** only insures shipments with the shipping company when asked to do so in writing by our customer. If you need your shipments insured, please forward a written request to **ENMET** Customer Service.

Regarding Shortages

If there are any shortages or questions regarding this shipment, please notify **ENMET** Customer Service within 5 days of receipt at the following address:

ENMET
680 Fairfield Court
Ann Arbor, MI 48108
734-761-1270 Fax 734-761-3220
Toll Free: 800-521-2978

1.2 Check Order

Check the contents of the shipment against the purchase order. Verify that the **EX-5165** is received as ordered. [Each **EX-5165** is labeled with its target gas.] If there are accessories on the order, ascertain that they are present. Check the contents of calibration kits. Notify **ENMET** customer service personnel of any discrepancy immediately.

1.3 Serial Numbers

Each **E** is serialized. These numbers are on tags on the equipment and are on record in an **ENMET** database.

2.0 Features of the EX-5165

See **Figure 1** for location of features:

Feature	Description
Display	LCD: Indicates the level of gas detected by sensor
Gain Potentiometer (POT)	POT 1: Display contrast adjustment POT 2: } POT 3: } Not Used, <i>do not adjust</i> POT 4: }
Visual Alarms	LED indicators: Power / Fault Indicator LED, Green / Red Alarm (3) Indicator Red LED, user adjustable
Magnetic Switches	MENU: Advances the instrument display through menus (Zero, Span, Exit) SELECT: Selects the Zero, Span, exit menu or sets proper calibration values for Zero or Span
Infrared Sensor	For sensing gas at percent levels, see Section 6.0 for sensor types

Magnetic switches control the instrument maintenance functions. The switch locations are indicated by **MENU** and **SELECT**. A magnetic field pulse is applied by momentarily putting the end of the magnet in proximity to the switch and then removing it. Referred to as tap. Since the magnetic field penetrates the window, the enclosure cover is not removed to perform calibration. Three alarm points are preprogrammed into the **EX-5165** sensor/transmitters. At each alarm point, an LED on the front panel is activated. These internal alarm settings are independent of the 4-20mA output alarm values that can be set at a controller.

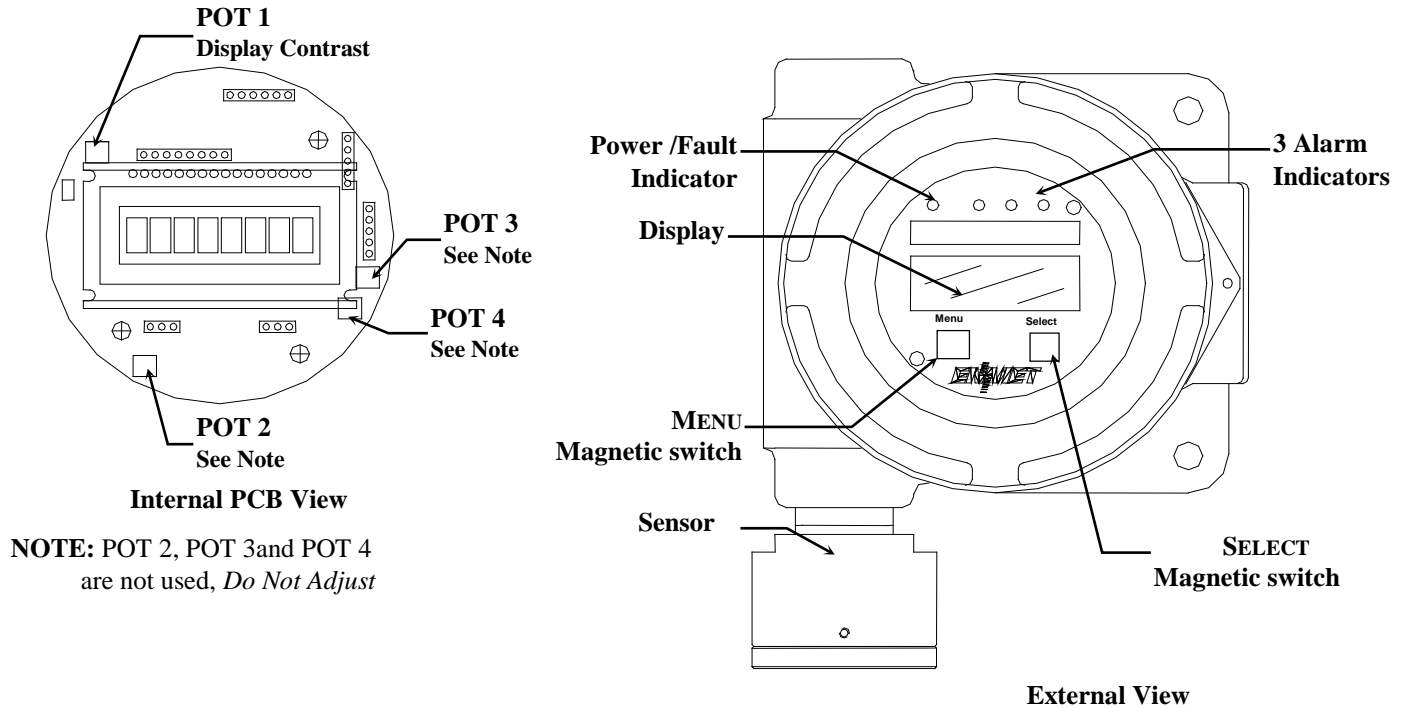

Figure 1: EX-5165 Features

3.0 Installation of the EX-5165

CAUTION: Area must be declassified during installation.

The **ENMET EX-5165** gas sensor/transmitter (S/T) is a 3-wire, 24 VDC, 4-20 mA S/T for the detection of Carbon Dioxide. The S/T is meant to be used in conjunction with an appropriate power supply and controller. The **ENMET EX-5165** sensor/transmitter has been designed and approved to be used in a Class I, Div. 1, Groups B, C, D, classified areas. The approval was issued by CSA International. Appropriate wiring, conduit and fittings are required for proper installation in a explosion proof rated environment.

CAUTION: Since the sensor/transmitter detects gas only at the sensor location, pay attention to the possible sources of gas, the density of the gas, locations where the gas may be confined and locations where the gas may damage or injure property or personnel, when choosing locations of sensor/transmitters.

Also, take into consideration environmental factors when deciding on S/T location. Avoid locations where the S/T may be damaged by liquid immersion, excessive heat or other known hazards. Also, take precautions to insure condensation inside of the conduit does not enter the S/T.

3.1 Mounting the EX-5165 Enclosure

Mount the enclosure, using the two mounting holes provided see **Figure 2**. Pay particular attention to the source and density of the gas being detected when choosing the location. Contact **ENMET** if you have questions regarding your application.

CAUTION: Before connecting S/T to controller remove the power source to controller. Failure to do so may cause damage to sensitive components.

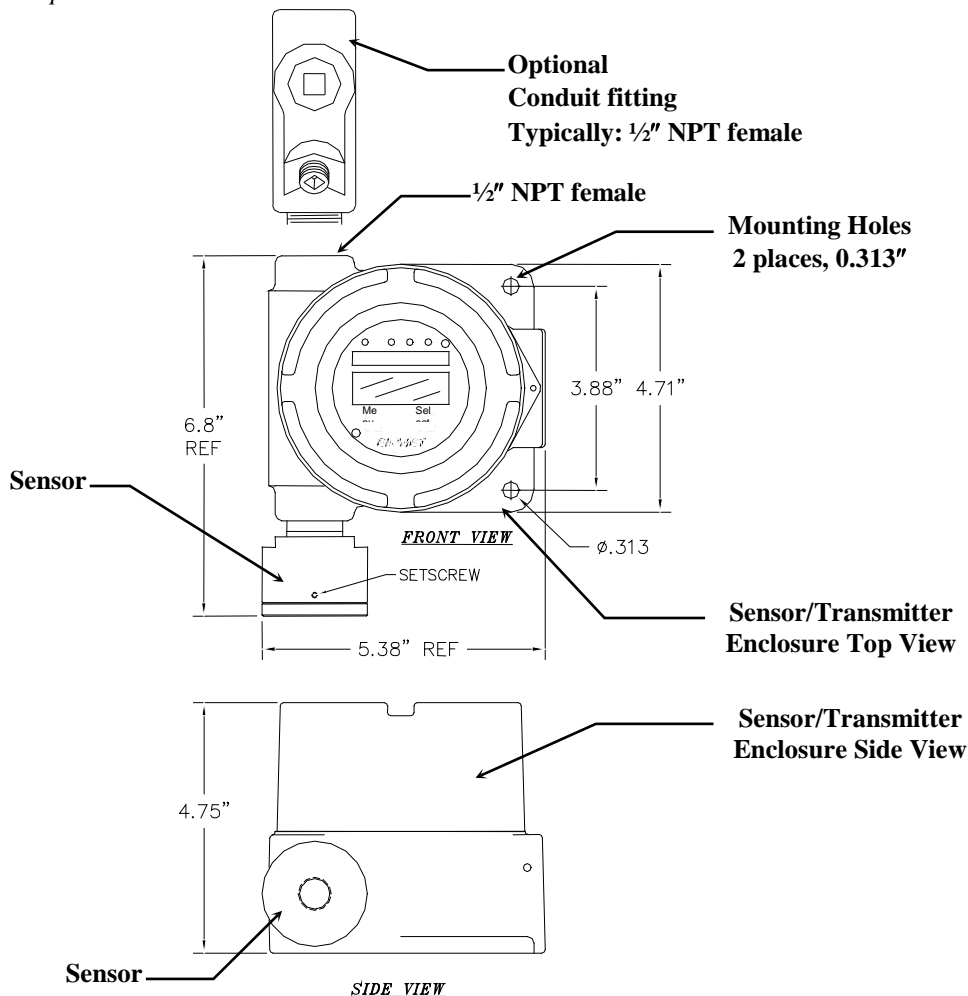

Figure 2: EX-5165 Mounting Dimensions

3.2 Wiring the EX-5165 to a Control Unit

CAUTION: Area must be declassified during installation.

Run conduit and 16 AWG (1.5MM²) wires to the enclosure from the power supply and controller. If the **EX-5165** is installed in a hazardous location as defined by the National Electrical Code, then *ALL* wiring must be in accordance with the National code and any local governing codes.

Open the enclosure, and remove the 2 screws that retain the display overlay to the circuit board.

Use caution when removing the over lay. Do not damage the magnetic switches.

Remove the two overlay standoffs and remove the circuit board, exposing the terminal strips on the bottom of the circuit board.

Do not disconnect the circuit board wiring.

Connect the wires from the controller (power supply) to the supplied J4 plug then attach to J4 terminal.

Connect the wires from the sensor to the supplied J8 plug then attach to the J8 terminal.

See **Figure 3** for locations

J4 PLUG – TERMINAL TO CONTROLLER WIRING

Position	Function
1 +	24 VDC power
2 -	GND
3 s	4 - 20 mA out
4*	RS-485 D+
5*	RS-485 D-

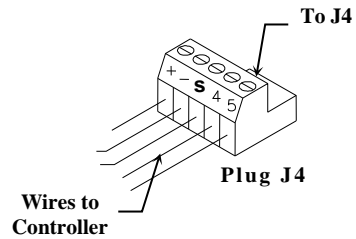

*Contact **ENMET** for Modbus Address information

J8 PLUG – TERMINAL TO SENSOR WIRING

Position	Function	Sensor
1 +	Power	Red
2 s	Signal	White
3 -	GND	Black

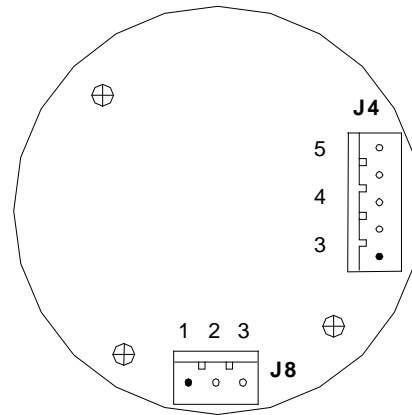
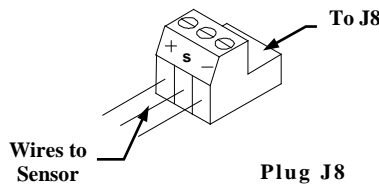

Circuit Board Bottom View

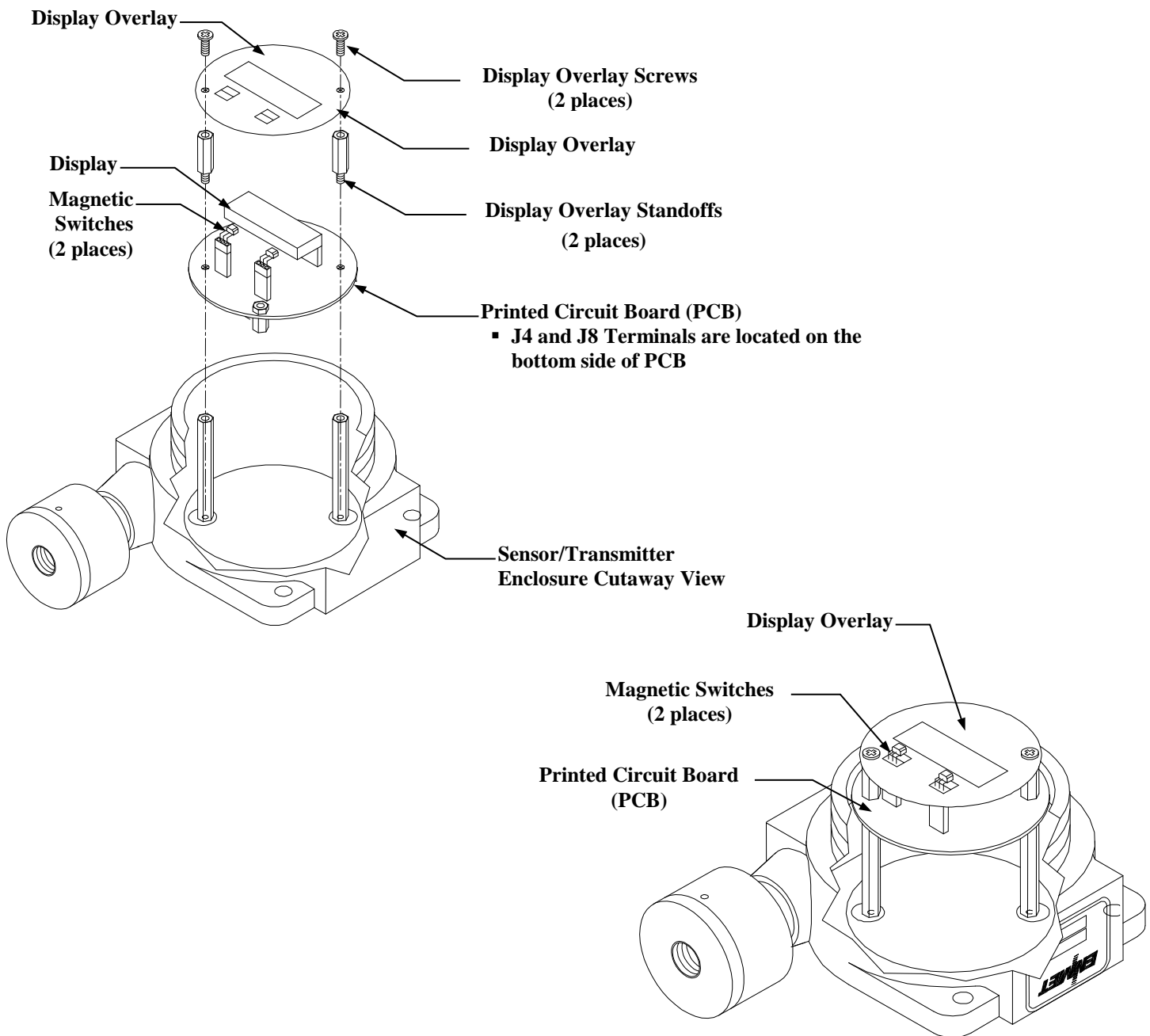

Figure 3: Terminal Positions EX-5165 Sensor/Transmitter

When wiring is complete, reassemble the **EX-5165**. Use caution when installing the overlay so as not to damage the magnetic switches. Put the cover back on the S/T *Do Not* apply power to the S/T without the cover in place.

4.0 Operation of the EX-5165

It is best to have the **EX-5165** transmitters powered up, operational and stable for several minutes before applying calibration or test gas to them.

When the **EX-5165** transmitter is first powered up, it goes through a series of momentary screens, which identify the instrument model number, serial number and software revision. After all of the momentary screens have been displayed, the instrument arrives at the Main Gas Display showing the gas concentration and unit of measurement.

Depending on transmitter configuration and calibration condition, the furthest right character in the display may flash a letter indicating the instrument status. Consult *ENMET* Distributor or *ENMET* for additional information.

4.1 Start up

4.1.1 Typical Start Up

When power is supplied to the **EX-5165**, the S/T will display the following sequence of information:

NOTE: *Software revision may cause variations of display output.*

Example of Display	Function
EX-5165	The instrument: Model EX-5165
75-1256	The instrument: Serial Number
S/W X.X	The instrument: Software Revision
IF the right most character is a flashing W <div style="text-align: center; border: 1px solid black; padding: 2px;">0% W</div>	The instrument is in Warm-up mode This should last about 1 minute The Signal Output is held at 4mA during warm-up
0%	The instrument: Normal Display Mode Measurement of target Gas

4.2 Normal Display Mode

When the **EX-5165** is installed as described in section 3, and in clean air, the POWER green LED is on, the display is lit and the information on the display is measurement of the target gas detected by the **EX-5165**. The red alarm and fault LEDs are not lit. To advance through displays of operational information tap the magnet over the **MENU** button.

NOTE: *Software revision may cause variations of display output.*

See sequence of operational information below:

Display Measurement of the target gas Tap the magnet over the MENU button	0% MENU	SELECT	No Function for the SELECT button in this mode
Display indicates Alarm 1 Set point Tap the magnet over the MENU button	A1: 5.0 MENU	SELECT	
Display indicates Alarm 2 Set point Tap the magnet over the MENU button	A2: 10.0 MENU	SELECT	
Display indicates Alarm 3 Set point Tap the magnet over the MENU button	A3: 15.0 MENU	SELECT	
Display indicates mA Span range (Full Scale) Tap the magnet over the MENU button Display returns to gas measurement	mA: 20.0 MENU	SELECT	

Operational Display Flow Chart

4.2.1 Alarm Conditions EX-5165

There are three alarm set points available. The alarm set points can be changed within limits; see the maintenance section of this manual for the procedure.

If the gas concentration increases above that of the alarm set point, the associated red LED is lit.

5.0 Maintenance of the EX-5165

CAUTION: Do not open the **EX-5165 S/T** in a classified area.

CAUTION: Do Not Attempt A Span Procedure Without Calibration Gas Applied to The Sensor; if this is done, the S/T is forced into a calibration fault mode.





Magnetic switches control the **MENU** and **SELECT** functions. The **MENU** and **SELECT** switch locations are indicated on the display panel, see **Figure 3**. The **MENU** switch is used to display the various menu options and make incremental changes to numbers such as alarm points, calibrations gas, etc. The **SELECT** switch is used to select that option, set zero or span digit. Most maintenance functions are controlled by simple taps of the supplied magnet on the transmitter glass, below the **MENU** and **SELECT** boxes on the front panel.

5.1 Maintenance Menu

To enter the maintenance menu, hold the magnet over the **MENU** switch for 2 to 4 seconds

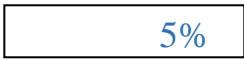
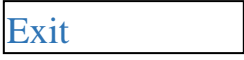
Table 1 indicates the maintenance menu sequence see **Figure 5** for a detailed maintenance menu flow chart.

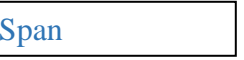
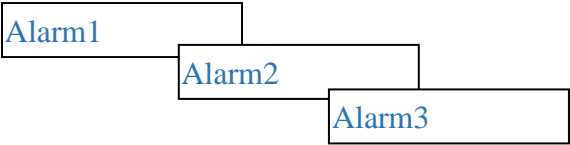
Table 1: EX-5165 Maintenance Menus Sequence

Example of Display	Function
	Normal Display Mode Measurement of target gas
Hold the magnet over MENU switch for 2 – 5 seconds to enter the Maintenance Menu The Power/Fault LED will flash Green – Red to indicate the EX-5165 is in Maintenance Mode	
	To exit the maintenance Menu and return to the Normal Display Mode: If intended function Tap the magnet over, SELECT switch
Tap the magnet over the MENU switch to advance to the Zero procedure	
	For adjusting Zero: If intended function Tap the magnet over, SELECT switch
Tap the magnet over the MENU switch to advance to the Span procedure	
	For adjusting the Span: If intended function Tap the magnet over, SELECT switch
Tap the magnet over the MENU switch to advance to each Alarm set point procedures	
	For adjusting the Alarm 1, 2 and 3 set points: If Intended function, tap the magnet over SELECT switch
Tap the magnet over the MENU switch to advance the mA Span set point procedure	
	For adjusting the mA Span set point: If intended function Tap the magnet over, SELECT switch

Taping the **MENU** switch without taping the **SELECT** switch will allow you to cycle through the menu options. You must Tap the **SELECT** switch to change the desired operation.

NOTE: If the S/T fails to respond, the magnet may have become weak and may need to be replaced.

5.2 Calibration of the EX-5165

Calibration is the process of setting the instrument up to read accurately when exposed to a target gas. The Zero function sets the clean air reference point and the Span function sets the sensitivity of the instrument.

Initial Calibration: Wait several minutes for stabilization after supplying power to the **EX-5165** sensor/transmitter (S/T) before initial calibration. The S/T has been precalibrated at the factory, and initial field calibration should result in only fine tuning to circuit, as well to check that installation is successful. It is not necessary to open the enclosure to make adjustment. The calibration functions are operated with magnets from outside the enclosure through the MENU and SELECT switches. Do Not open the S/T unless the area is de-classified.

Calibration Zero and Span functions are two separate procedures. They operate independently of each other. It is recommended that the Zero procedure be done prior to the Span procedure. **ENMET** recommends at least quarterly calibration of the **EX-5165** transmitters.

Calibration equipment is available from **ENMET** to calibrate the **EX-5165** sensor/transmitters. A calibration adapter will have a fitting for the gas cylinder on one side, and a cover to go over the sensor housing on the other.

Generally, a cylinder of 20.9% Oxygen is used to provide a fresh air reference or Zero point for the calibration. Another cylinder is used to provide the Span reference point for calibration. Depending on the instrument calibration, the Span gas may be the same gas that the instrument is calibrated to display, or it may be another gas, which **ENMET** has found to have a similar response.

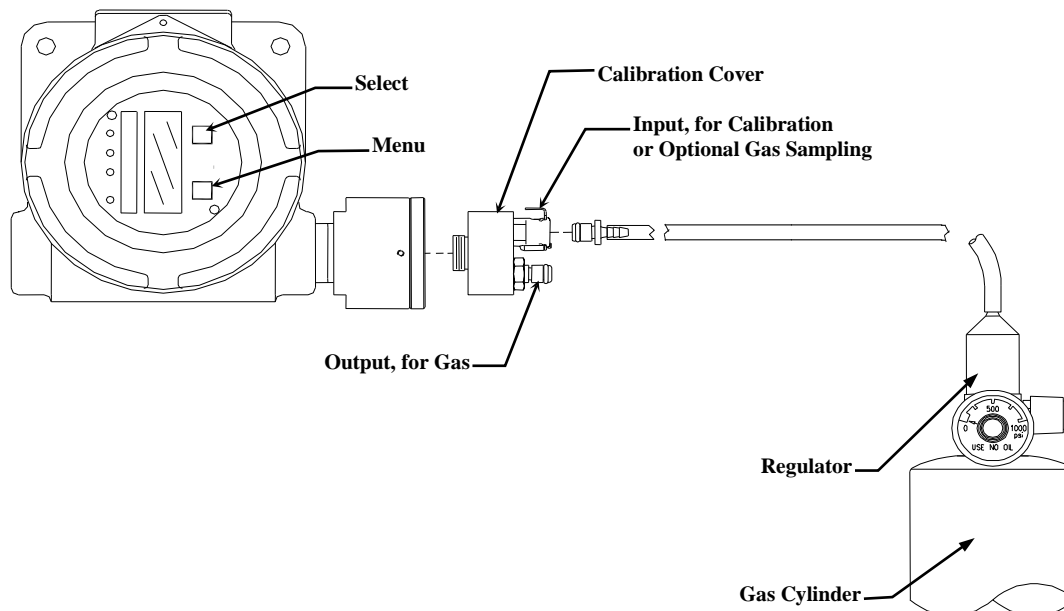

Figure 4: Calibration Adapter EX-5165 Sensor/Transmitter

5.2.1 Zero Adjust

A ZERO function should be performed only when the **EX-5165** sensor/transmitter is exposed to fresh air. If the air at the sensor is in question, use a cylinder of 20.9% oxygen to provide a clean air reference. Attach the cylinder to the calibration adapter. Enter the maintenance menu by placing the magnet over **MENU** switch for 2 to 4 seconds. See **Figure 5, EX-5165** Maintenance Menu flow chart.

The second menu available is the Zero.

Tap the **SELECT** switch to perform a Zero.

- *If the Zero is successful*, Cal OK appears on the display and in 1 – 2 seconds, display will change to Span. If you wish to Span the sensor Tap the **SELECT** switch you are now ready to apply gas. **Proceed to gas span step 2**
- If you wish to Exit the maintenance menu, Tap **MENU** switch until Exit is displayed, then tap **SELECT** switch to return to the instrument Normal Gas Display
- *If the Zero is Not successful*, sensor is outside of safe parameters to be zeroed, the display will read Bad Zero. Repeat Section 5.2.1 Zero Adjust making sure to use a cylinder of 20.9% Oxygen.

5.2.2 Gas Span

It is recommended that the Zero Function be performed first.

Enter the maintenance menu. See **Figure 5, EX-5165** Maintenance Menu flow chart.

1. Tap the **MENU** switch once to show Span on the display.
2. Tap the **SELECT** switch to perform a Span procedure. The display will alternate between the calibration gas concentration and a signal level.

NOTE: You can change the Calibration Gas Level. **HOLD** the magnet over the **SELECT** switch for 2 – 4 seconds

The **MENU** switch changes digit indicated by underscore cursor

The **SELECT** switch locks underscored digit and moves to next digit

3. Attach the associated calibration gas cylinder to the regulator and calibration cover. See to **Figure 4**.
4. Open the valve to apply the calibration gas to the sensor.
5. Watch for the signal level to stabilize.
6. Once the signal level has stabilized, the **EX-5165** will automatically lock in the calibration data and:
 - If the Span is successful, Cal OK appears on the display momentarily, then advances to Alarm 1. Remove calibration gas. To exit maintenance menu, tap the **MENU** switch until Exit appears, then tap the **SELECT** switch.
 - If the sensor is outside of acceptable parameters, Bad Span is displayed momentarily, then returns to Span. Remove calibration gas. Tap the **MENU** switch until Exit appears, then tap the **SELECT** switch. Check span gas and repeat calibration.

NOTE: Some software revisions require the **SELECT** switch be tapped to accept the signal.

7. Calibration is complete.

5.2.3 Exit Maintenance Menu

Exit maintenance, by tapping on the **MENU** switch until Exit appears on the display. Tap the **SELECT** switch to return to the instrument Normal Gas Display.

Normal Display Mode

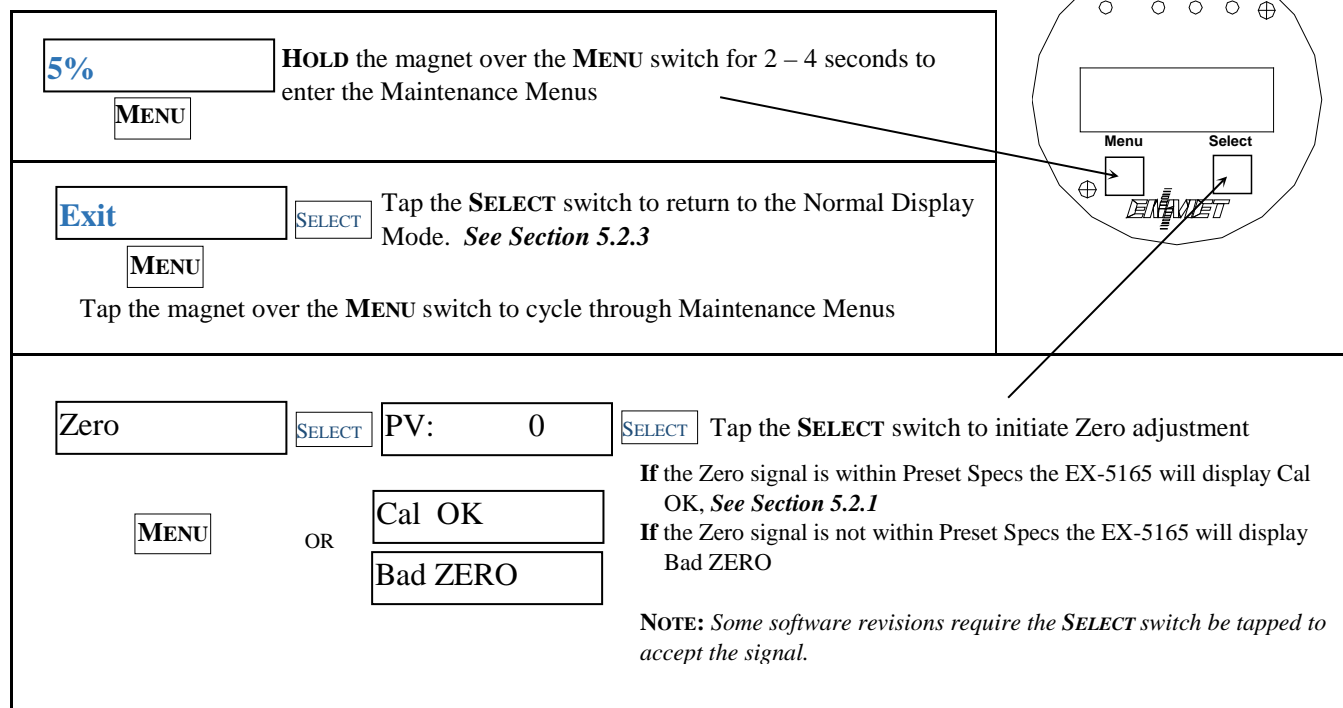

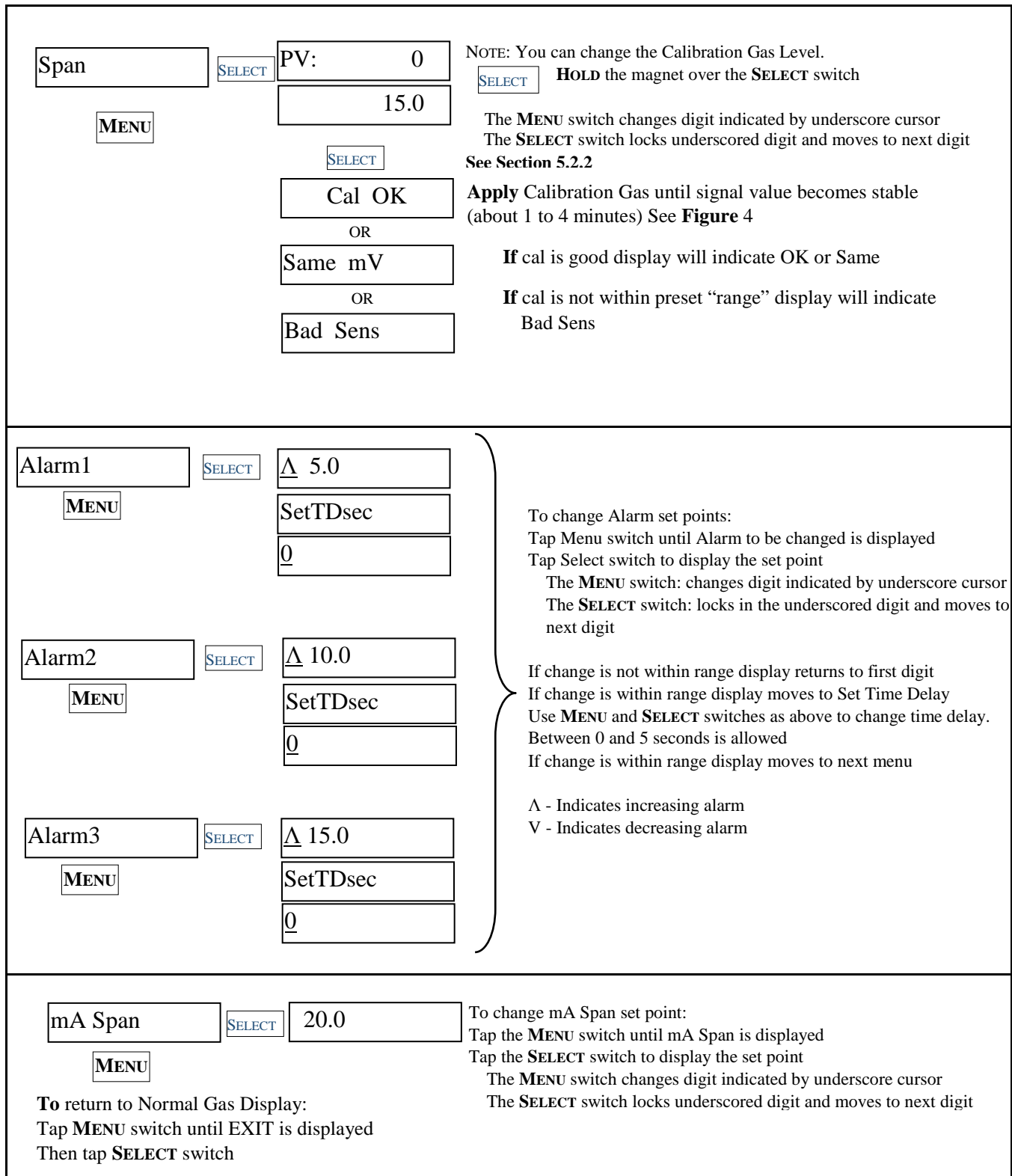

Figure 5: EX-5165 Maintenance Menu Flow Chart

5.3 Sensor Replacement

CAUTION: Area must be declassified during sensor replacement.

Sensors should be replaced when they can no longer be calibrated. Replacement sensor part numbers are listed in Section 6.0 of this manual. If you do not know the proper part number for your sensor, be sure to have the **EX-5165** serial number available when contacting your Distributor or **ENMET** Technical Support.

To replace a sensor, it is not necessary to open the transmitter housing.

Remove the set screw from sensor housing base.

Unscrew the sensor housing cover and remove Sensor/PC Board Assembly.

NOTE: Sensor and PC Board are attached and should not be separated from each other.

Plug in new Sensor/PC Board Assembly.

Reassemble the sensor housing.

After the new sensor, has been installed, it is suggested to allow the sensor to stabilize for several minutes.

A Factory calibration must be performed.

After entering the Maintenance menu, advance to the Zero menu. Then while viewing the Zero menu, hold the magnet over the **MENU** switch for 2-4 seconds.

After 2-4 seconds, an F will appear on the far-right hand side of the display. The F indicates that the instrument is in Factory mode.

Perform the calibration Zero and Span procedures as outlined in Section 5.2. Be sure that the F is present when selecting the Zero and Span functions.

The Factory calibration sets a calibration window for future standard instrument calibrations.

Only perform a factory calibration when installing a new sensor!!

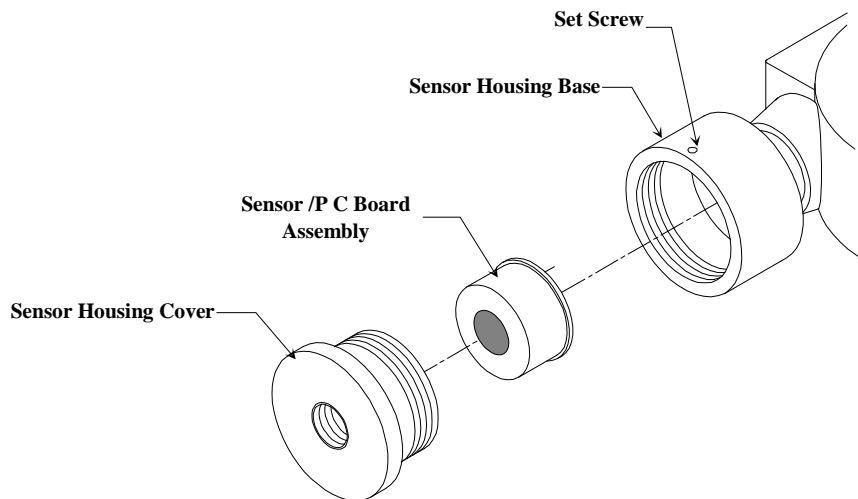

Figure 6: Sensor Replacement

6.0 Replacement Part Numbers

ENMET replacement part numbers:

Description	Part Number
Sensor, Infrared Carbon Dioxide for 0 – 2,000 ppm	03053-025
Sensor, Infrared Carbon Dioxide for 0 – 5,000 ppm	03053-027
Sensor, Infrared Carbon Dioxide for 0 – 10,000 ppm	03053-029
Sensor, Infrared Carbon Dioxide for 0 – 2%	03053-033
Sensor, Infrared Carbon Dioxide for 0 – 5%	03053-039
Sensor, Infrared Carbon Dioxide for 0 – 20%	03053-043
Sensor, Infrared Carbon Dioxide for 0 – 60%	03053-051
Consult <i>ENMET</i> Distributor or <i>ENMET</i> for additional ranges	
Regulator Assembly, for 34/58/103ℓ cylinders	02506-002
Magnet	50030-001
Calibration/Sampling Adapter	03700-034
Calibration Gas, 103ℓ cylinders, Carbon Dioxide 1,000ppm	03223-1000
Calibration Gas, 103ℓ cylinders, Carbon Dioxide 2,000ppm	03223-2000
Calibration Gas, 103ℓ cylinders, Carbon Dioxide 5,000ppm	03223-5000
Consult <i>ENMET</i> Distributor or <i>ENMET</i> for additional concentrations	

Notes:

7.0 Terms and Conditions

7.1 Ordering Information

Address orders to:

ENMET
Attention: Customer Service Department
680 Fairfield Court
Ann Arbor, MI 48108

Email Orders: orderentry@enmet.com

Phone: 734-761-1270

Fax: 734-761-3220

You may also contact our customer service department by email info@enmet.com. MINIMUM ORDER IS \$50.00.

7.2 Shipping Terms

All shipments are F.O.B. ENMET's facility in Ann Arbor, MI, USA or Bowling Green, KY, USA. Shipping and handling charges are prepaid and added, and must be paid by the customer. Shipping and handling charges may be billed to VISA, MasterCard, American Express, or to the customer's preferred carrier account number. Delivery to the carrier constitutes delivery to the customer, and risk of loss passes to the customer at that time, however, title shall remain with ENMET until payment is received in full. Claims for shortages and damage must be made by the customer to the carrier within 5 days of receipt. **Refer to section "1.1 Unpack" for more information on this matter.**

A special service of \$50.00, or more, may be assessed on expedited shipments.

NOTE: Calibration gases are classified as Dangerous Goods for transportation purposes, and shipping companies charge a hazardous material fee for processing the documentation required for handling such items. Also, other restrictions apply to shipment of Danger Goods by air. Check with **ENMET** for clarification and additional information.

7.3 Payment

Open accounts must be established in advance with ENMET's Accounting department.

Address Payments to:

ENMET
680 Fairfield Court
Ann Arbor, MI 48108

Phone: 734-761-1270

We accept payments by VISA, MasterCard, and American Express. Payment by credit card must be specified at time of order placement. Your credit card will be charged on the date of shipment.

ENMET invoices for products that are shipped on open account are due and payable 30 days from the date of shipment from the **ENMET** site. **ENMET** may institute collection services should any bona fide invoice remain unpaid with no payment schedule negotiated by the customer with the **ENMET** Accounting Department. Any cost incurred by **ENMET** for professional collection services or legal fees to collect on a customer invoice will be added to any future business conducted between **ENMET** and that customer.

7.4 Warranty Information and Guidelines

Equipment must be returned prepaid to the point of origin, and ENMET will prepay the return transportation charges. Transportation prepaid by ENMET will be by most economical means (e.g. FedEx Ground). If an expedient means of transportation is requested during the warranty period, the customer must pay the difference between the most economical means and the expedient mode. ENMET warrants new instruments to be free from defects in workmanship and material under normal use for a calibration and expendable parts such as filters, detector tubes, batteries, etc. In addition, some oxygen cells and other sensors are limited to a warranty period of six months from date of shipment. Refer to the instrument manual for specific warranty details. If the inspection by ENMET confirms that the product is defective, it will be repaired or replaced at no charge, within the stated limitations, and returned prepaid by FedEx Ground to any location in the United States. ENMET shall not be liable for any loss or damage caused by the improper use or installation of the product. The purchaser indemnifies and holds harmless the company with respect to any loss or damages that may arise through the use by the purchaser or others of this equipment. This warranty is expressly given in lieu of all other warranties, either expressed or implied, including that of merchantability, and all other obligations, or liabilities of ENMET which may arise in connection with this equipment. ENMET neither assumes nor authorizes any representatives or other persons to assume for it any obligation or liability other than that which is set forth herein.

If a component is purchased and installed in the field, and fails within the warranty term, it can be returned to ENMET and will be replaced, free of charge. If the entire instrument is returned to ENMET with the defective item installed, it will be replaced at no cost, but the instrument will be subject to labor charges at half of the standard rate.

NOTE: When returning an instrument to the ENMET for service:

- o Be sure to include all paperwork (the “Request for Service” form).
- o Include any specific instructions.
- o For warranty service, include the date of purchase.
- o If you require an Estimate, please contact ENMET.

The “Request for Service” form is on the final page of this manual. This form can be copied or used as needed. For service requests, outside of the warranty period, please refer to the “Returning an Instrument for Service Instruction” found later in this section.

7.5 Return Policy

All returns for credit must be approved by ENMET and identified with a “Return Material Goods” number. Such returns are subject to a minimum of a \$50.00 or 20% restocking fee, whichever is greater. **Approval of equipment for return is fully at the discretion of ENMET.** All requests for return/exchange must be made no later than 30 days of the original shipping date from *ENMET*. The actual amount of any resulting credit will not be determined prior to a complete inspection of the equipment by *ENMET*. Calibration gas cylinders cannot be returned or restocked due to the Department of Transportation refill restrictions. Air Filtration Systems (AFS series & parts) cannot be returned or restocked because their internal surfaces and filters are not amenable to re-inspection.

Certain products, such as stationary systems, or instruments with custom sensor configuration (non-standard) are built to order, and cannot be returned. Cancellation of orders for custom-built products, prior to shipment, will result in the assessment of a cancellation fee. The amount of the cancellation fee will be based upon the size and complexity of the order, and the percentage of total cost expended prior to cancellation.

7.6 Returning an Instrument for Service Instructions

Contact the ENMET Service Department for all service requests.

Phone: 734-761-1270

Email: repair@enmet.com

Fill out the “Service Request Form” found at the end of this manual and return with your instrument for all needs. Please send your instrument for service to the site in which the product was purchased. A new “Service Request Form” may be requested if the one found in the manual is not available. All instruments should be shipped prepaid to ENMET.

Address for Service:

Michigan Location:

ENMET
Attention: Service Department
680 Fairfield Court
Ann Arbor, MI 48108

Kentucky Location:

ENMET
62 Corporate Court
Bowling Green, KY 42103

Providing the “Service Request Form” assists in the expedient service and return of your unit and failure to provide this information can result in processing delays. *ENMET* charges a one hour minimum billing for all approved repairs with additional time billed to the closest tenth of an hour. All instruments sent to *ENMET* are subject to a minimum evaluation fee, even if returned unrepared. Unclaimed instruments that *ENMET* has received without appropriate paperwork or attempts to advise repair costs that have been unanswered after a period of 60 days may, be disposed of or returned unrepared COD and the customer will be expected to pay the evaluation fee. Serviced instruments are returned by UPS/FedEx Ground and are not insured unless otherwise specified. If expedited shipping methods or insurance is required, it must be stated in your paperwork.

NOTE: Warranty of customer installed components.

For Warranty Repairs, please reference *ENMET*’s “Warranty Information and Guidelines” (found earlier in this section).

Mailing/Shipping Address:

ENMET
680 Fairfield Court
Ann Arbor, MI 48108
repair@enmet.com



Phone: 734.761.1270
Fax: 734.761.3220

Service Request Form

Product Name or Number:

Product Serial Number:

Describe Problem or Needed Service:

Warranty Claim? Yes No

CUSTOMER INFORMATION

Billing Address:

Shipping Address:

Contact Name:

Phone #:

Email:

Fax #:

PO/Reference

#:

PAYMENT METHOD

- COD VISA/MasterCard American Express

Card Number

Exp. Date

Security Code:

Name as it Appears on

Card:

RETURN SHIPPING METHOD

- UPS Ground UPS 3 Day Select UPS Next Day Air UPS ND Air Saver UPS 2 Day Air

UPS Account #: _____

- FedEx Ground FedEx Air Express Saver FedEx Air Overnight Std. FedEx Air 2 Day FedEx Air Overnight P-1

FedEx Account #: _____

Insure Shipment: Yes No

Insurance \$
Amount: _____